

ELIMINATOR[®]

LIGHTING

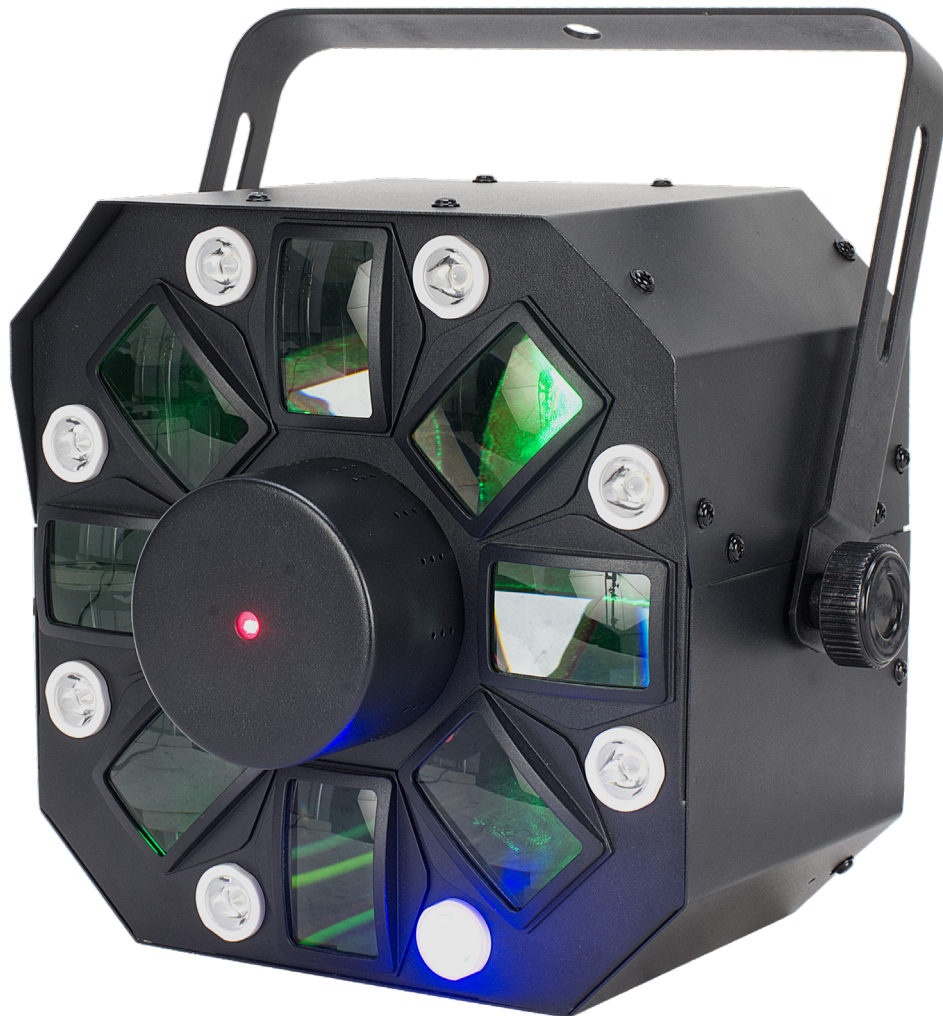

FURIOUS THREE RG

User Instructions

SKU#: FUR128
UPC#: 818651029314

©2022 ADJ Products, LLC all rights reserved. Information, specifications, diagrams, images, and instructions herein are subject to change without notice. Eliminator Lighting, ADJ Products, LLC logo and identifying product names and numbers herein are trademarks of ADJ Products, LLC. Copyright protection claimed includes all forms and matters of copyrightable materials and information now allowed by statutory or judicial law or hereinafter granted. Product names used in this document may be trademarks or registered trademarks of their respective companies and are hereby acknowledged. All non-ADJ Products, LLC brands and product names are trademarks or registered trademarks of their respective companies.

ADJ Products, LLC and all affiliated companies hereby disclaim any and all liabilities for property, equipment, building, and electrical damages, injuries to any persons, and direct or indirect economic loss associated with the use or reliance of any information contained within this document, and/or as a result of the improper, unsafe, insufficient and negligent assembly, installation, rigging, and operation of this product.

ADJ PRODUCTS LLC World Headquarters

6122 S. Eastern Ave. | Los Angeles, CA 90040 USA

Tel: 800-322-6337 | Fax: 323-582-2941 | www.adj.com | lsupport@adj.com

ADJ Supply Europe B.V.

Junostraat 2 | 6468 EW Kerkrade | Netherlands

Tel: +31 45 546 85 00 | Fax: +31 45 546 85 99 | www.americandj.eu | service@americandj.eu

Europe Energy Saving Notice

Energy Saving Matters (EuP 2009/125/EC)

Saving electric energy is a key to help protecting the environment. Please turn off all electrical products when they are not in use. To avoid power consumption in idle mode, disconnect all electrical equipment from power when not in use. Thank you!

DOCUMENT VERSION



Due to additional product features and/or enhancements, an updated version of this document may be available online.

Please check www.eliminatorlighting.com for the latest revision/update of this manual before beginning installation and/or programming.

Date	Document Version	Software Version >	DMX Channel Mode	Notes
04/20/2021	1.0	1.0	9 Channels	Initial Release
04/20/2021	1.5	N/C	No change	Updated Graphics & Specifications
03/29/22	2.0	N/C	No change	Added accession number

CONTENTS

General Information	3
Limited Warranty (USA Only)	5
Safety Guidelines	6
Laser Warning	8
Overview	10
Installation	11
DMX Set Up	13
DMX Addressing	15
System Menu	16
DMX Traits: Channel Functions & Values	17
Dimmer Mode Chart	19
Cleaning Maintenance	20
Specifications	21

GENERAL INFORMATION

INTRODUCTION

Please read and understand all instructions in this manual carefully and thoroughly before attempting to operate these products. These instructions contain important safety and use information.

UNPACKING

The products in this kit have been thoroughly tested and have been shipped in perfect operating condition. Carefully check the shipping carton for damage that may have occurred during shipping. If the carton appears to be damaged, carefully inspect each unit included for damage and be sure all accessories necessary to operate the units have arrived intact. In the event damage has been found or parts are missing, please contact our customer support team for further instructions. Please do not return this kit to your dealer without first contacting customer support at the number listed below. Please do not discard the shipping carton in the trash. Please recycle whenever possible.

WARRANTY RETURNS

All returned service items whether under warranty or not, must be freight pre-paid and accompany a return authorization (R.A.) number. The R.A. number must be clearly written on the outside of the return package. A brief description of the problem as well as the R.A. number must also be written down on a piece of paper and included in the shipping container. If the unit is under warranty, you must provide a copy of your proof of purchase invoice. Items returned without a R.A. number clearly marked on the outside of the package will be refused and returned at customer's expense. You may obtain a R.A. number by contacting customer support.

LIMITED WARRANTY (USA ONLY)

- A. Eliminator Lighting, an ADJ Products, LLC brand, hereby warrants, to the original purchaser, ADJ Products, LLC products to be free of manufacturing defects in material and workmanship for a prescribed period from the date of purchase (see specific warranty period on reverse). This warranty shall be valid only if the product is purchased within the United States of America, including possessions and territories. It is the owner's responsibility to establish the date and place of purchase by acceptable evidence, at the time service is sought.
- B. For warranty service, you must obtain a Return Authorization number (RA#) before sending back the product-please contact ADJ Products, LLC Service Department at 800-322-6337. Send the product only to the ADJ Products, LLC factory. All shipping charges must be pre-paid. If the requested repairs or service (including parts replacement) are within the terms of this warranty, ADJ Products, LLC will pay return shipping charges only to a designated point within the United States. If the entire instrument is sent, it must be shipped in its original package. No accessories should be shipped with the product. If any accessories are shipped with the product, ADJ Products, LLC shall have no liability whatsoever for loss of or damage to any such accessories, or for the safe return thereof.
- C. This warranty is void if the serial number has been altered or removed; if the product is modified in any manner which ADJ Products, LLC concludes, after inspection, affects the reliability of the product, if the product has been repaired or service by anyone other than ADJ Products, LLC factory unless prior written authorization was issued to purchaser by ADJ Products, LLC; if the product is damaged because not properly maintained as set forth in the instruction manual.
- D. This is not a service contract, and this warranty does not include maintenance, cleaning or periodic check up. During the period specified above, ADJ Products, LLC will replace defective parts at its expense with new or refurbished parts, and will absorb all expenses for warrant service and repair labor by reason of defects in material or workmanship. The sole responsibility of ADJ Products, LLC under this warranty shall be limited to the repair of the product, or replacement thereof, including parts, at the sole discretion of ADJ Products, LLC. All products covered by this warranty were manufactured after August 15, 2012, and bear identifying marks to that effect.
- E. ADJ Products, LLC reserves the right to make changes in design and/or improvements upon its products without any obligation to include these changes in any products theretofore manufactured.
- F. No warranty, whether expressed or implied, is given or made with respect to any accessory supplied with products described above. Except to the extent prohibited by applicable law, all implied warranties made by ADJ Products, LLC in connection with this product, including warranties of merchantability or fitness, are limited in duration to the warranty period set forth above. And no warranties, whether expressed or implied, including warranties of merchantability or fitness, shall apply to this product after said period has expired. The consumer's and/or Dealer's sole remedy shall be such repair or replacement as is expressly provided above; and under no circumstances shall ADJ Products, LLC be liable for any loss or damage, direct or consequential, arising out of the use of, or inability to use, this product.
- G. This warranty is the only written warranty applicable to ADJ Products, LLC Products and supersedes all prior warranties and written descriptions of warranty terms and conditions heretofore published.

LIMITED WARRANTY PERIODS

- **All Eliminator Lighting products (except laser diodes) = 1-year (365 days) Limited Warranty** (Such as: Special Effect Lighting, Intelligent Lighting, UV lighting, Strobes, Fog Machines, Bubble Machines, Mirror Balls, Par Cans, Trussing, Lighting Stands etc. excluding LED and lamps)
- **Laser Products = 1 Year (365 Days) Limited Warranty** (excludes laser diodes which have 6 month limited warranty)
- **Batteries = 180 Day Limited Warranty** (excluding batteries which have a 180 day limited warranty)

SAFETY GUIDELINES

To guarantee a smooth operation, it is important to follow all instructions and guidelines in this manual. ADJ Products, LLC is not responsible for injury and/or damages resulting from the misuse of this fixture due to the disregard of the information printed in this manual. Only qualified and/or certified personnel should perform installation of this fixture and only the original rigging parts included with this fixture should be used for installation. Any modifications to the fixture and/or the included mounting hardware will void the original manufactures warranty and increase the risk of damage and/or personal injury.



PROTECTION CLASS 1 - FIXTURE MUST BE PROPERLY GROUNDED



THERE ARE NO USER SERVICEABLE PARTS INSIDE THIS UNIT. DO NOT ATTEMPT ANY REPAIRS YOURSELF; DOING SO WILL VOID YOUR MANUFACTURES WARRANTY. DAMAGES RESULTING FROM MODIFICATIONS TO THIS FIXTURE AND/OR THE DISREGARD OF SAFETY INSTRUCTIONS AND GUIDELINES IN THIS MANUAL VOID THE MANUFACTURES WARRANTY AND ARE NOT SUBJECT TO ANY WARRANTY CLAIMS AND/OR REPAIRS.



**DO NOT PLUG FIXTURE INTO A DIMMER PACK!
NEVER OPEN THIS FIXTURE WHILE IN USE!
UNPLUG POWER BEFORE SERVICING FIXTURE!
NEVER TOUCH FIXTURE DURING OPERATION AS IT MAY BE HOT!
KEEP FLAMMABLE MATERIALS AWAY FROM FIXTURE!**



**INDOOR / DRY LOCATIONS USE ONLY!
DO NOT EXPOSE DEVICES TO RAIN AND/OR MOISTURE!**

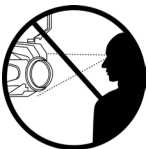

NEVER LOOK DIRECTLY INTO THE LIGHT SOURCE! RETINA INJURY RISK - MAY INDUCE BLINDNESS! SENSITIVE PERSONS MAY SUFFER AN EPILEPTIC SHOCK!

SAFETY GUIDELINES

This unit may “pop” the fuse if the maximum allotted load of 3 amps is reached.

- **To reduce the risk of electrical shock or fire, do not expose this unit rain or moisture.**
- **Do not spill water or other liquids into or on to your unit.**
- **Do not attempt to remove or break off the ground prong from the electrical cord. This prong is used to reduce the risk of electrical shock and fire in case of an internal short.**
- **Do not attempt to operate this unit if the power cord has been frayed or broken.**
- **Disconnect from main power before making any type of connection.**
- **Do not remove the cover under any conditions. There are no user serviceable parts inside.**
- **Always be sure to mount this unit in an area that will allow proper ventilation. Allow about 6” (15cm) between this device and a wall.**
- **Do not attempt to operate this unit if it has been damaged in any way.**
- **This unit is intended for indoor use only. Use of this product outdoors voids all warranties.**
- **During long periods of non-use, disconnect the unit’s main power.**
- **Always mount this unit in safe and stable matter.**
- **Power cords should be routed so they are not likely to be walked on, pinched by items placed upon or against them.**
- **Cleaning - The fixture should be cleaned only as recommended by the manufacturer. See the Maintenance Guidelines section of this manual for cleaning details.**
- **Heat - The appliance should be situated away from heat sources such as radiators, heat registers, stoves, or other appliances (including amplifiers) that produce heat.**
- **The fixture should be serviced by qualified service personnel when:**
 - A. The power-supply cord or the plug has been damaged.**
 - B. Objects have fallen, or liquid has been spilled into, the unit.**
 - C. The unit has been exposed to rain or water.**
 - D. The unit does not appear to operate normally or exhibits a marked change in performance.**

LASER WARNING



After completing setup, and before public use, test the laser to ensure proper function. Do not use if any defects are detected. Do not use if the laser emits only a few laser beams rather than dozens/hundreds, as this could indicate damage to the diffraction grating optic, and could allow emission of laser intensity levels that exceed Class 3R.

- Do not point lasers at people or animals. Never look into the laser aperture or directly at laser beams.
- Do not point lasers into areas which could create instances of unintentional or harmful exposure, such as uncontrolled balconies, etc.
- Do not point lasers at highly reflective surfaces, such as windows, mirrors, and shiny metal. Even laser reflections can be hazardous.
- Never point a laser at aircraft. This is a federal offense.
- Never point un-terminated laser beams into the sky.
- Do not expose the output optic (aperture) to cleaning chemicals.
- Do not use laser if the laser appears to be emitting only a few beams.
- Do not use the laser if the housing is damaged, the housing is open, or if the optics appear damaged in any way.
- Never open the laser housing. The high laser power levels inside of the protective housing can start fires, burn skin, and will cause instantaneous eye injury.
- Never leave this device running unattended.
- The operation of a class 3R laser show is only allowed if the show is controlled by a skilled and well-trained operator who is familiar with the information enclosed in this manual.
- The legal requirements for using laser entertainment products vary from country to country. The user is responsible for determining the legal requirements at the location/country of use.
- Always use proper lighting safety cables when hanging lights and effects overhead.

LASER WARNING

VISIBLE LASER RADIATION
AVOID EYE EXPOSURE TO DIRECT RADIATION
Class IIIa LASER PRODUCT

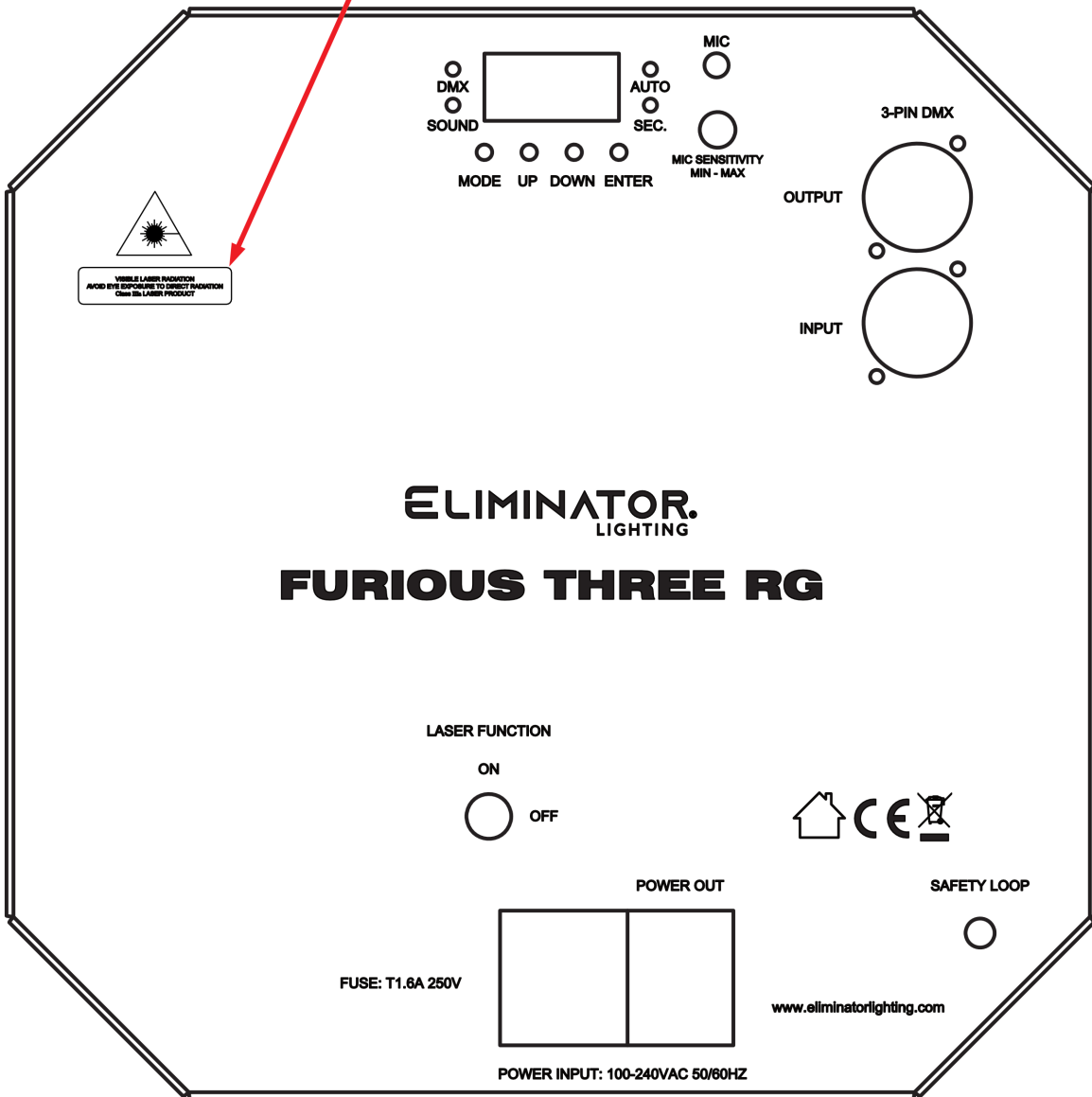

OVERVIEW

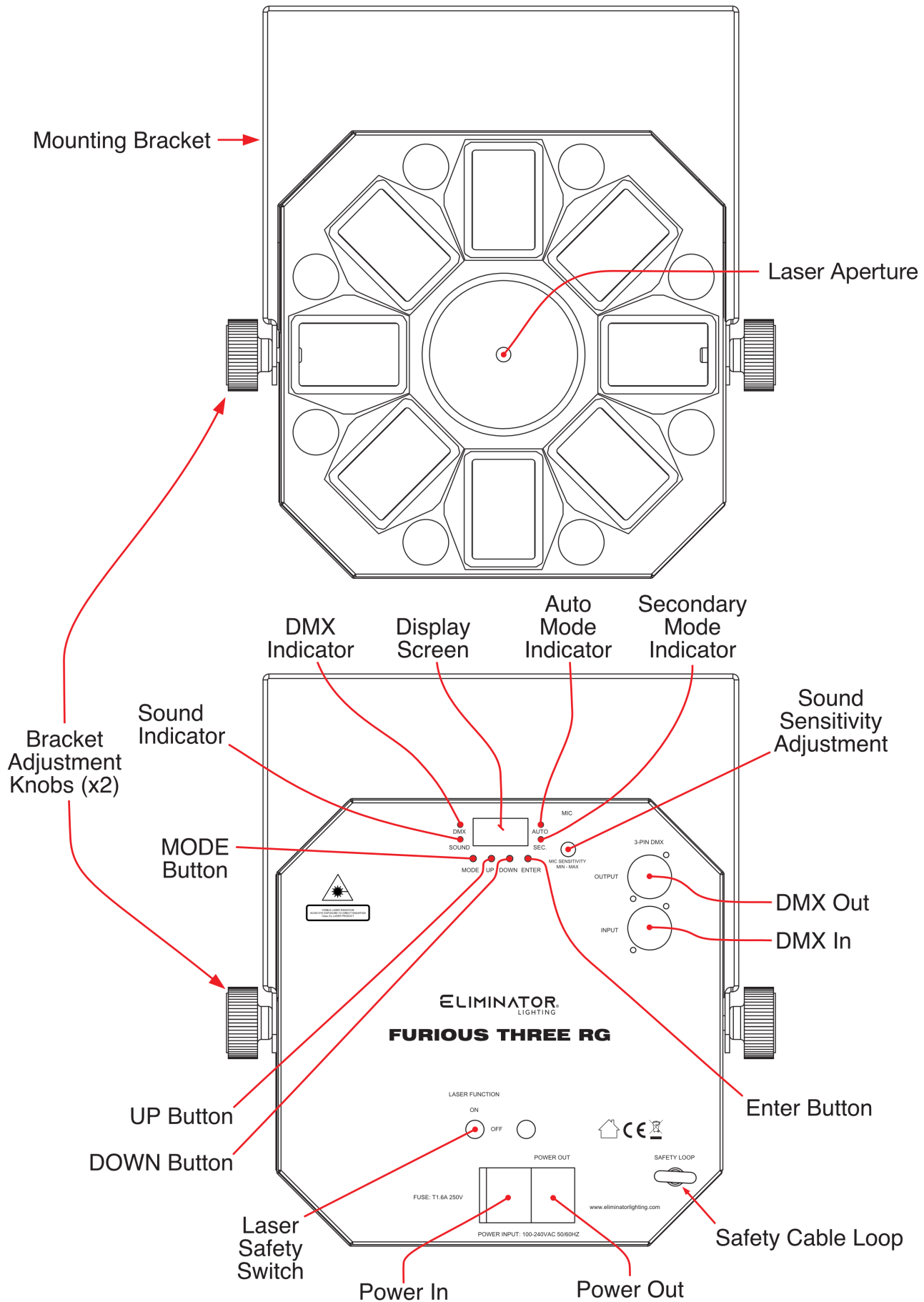

INSTALLATION



FLAMMABLE MATERIAL WARNING

Keep fixture at least 7.9in. (0.2m) away from any flammable materials, decorations, pyrotechnics, etc.



ELECTRICAL CONNECTIONS

A qualified electrician should be used for all electrical connections and/or installations.



MINIMUM DISTANCE TO OBJECTS/SURFACES MUST BE 40 FEET (12 METERS)



MAXIMUM TEMPERATURE OF EXTERNAL SURFACE 167°F (75°C)

DO NOT INSTALL THE FIXTURE IF YOU ARE NOT QUALIFIED TO DO SO!

Fixture **MUST** be installed following all local, national, and country commercial electrical and construction codes and regulations. Before rigging/mounting the fixture to any metal truss/structure or placing the fixture on any surface, a professional equipment installer **MUST** be consulted to determine if the metal truss/structure or surface is properly certified to safely hold the combined weight of the fixture, clamps, cables, and accessories.

Overhead fixture installation must always be secured with a secondary safety attachment, such as an appropriately rated safety cable that meets all local, national, and country codes and regulations.

Fixture ambient operating temperature range is **-4°F to 104°F. (-20°C to 40°C)** Do not use this fixture outside this temperature range.

Fixture should be installed in areas outside walking paths, seating areas, or away from areas where unauthorized personnel might reach the fixture by hand.

NEVER stand directly below the fixture when rigging, removing, or servicing.

Allow approximately 15-minutes for the fixture to cool down before servicing.

INSTALLATION

CLAMP INSTALLATION

This fixture features a mounting clamp attachment point, which is located on the mounting yoke, as well as a safety cable rigging point, located on the rear face of the unit near the power connection (see the illustration below). When mounting the fixture to a truss or any other suspended or overhead installation, be sure to secure an appropriately rated clamp (not included) to the clamp attachment point and attach a separate SAFETY CABLE of the appropriate safety rating to the safety cable rigging point.

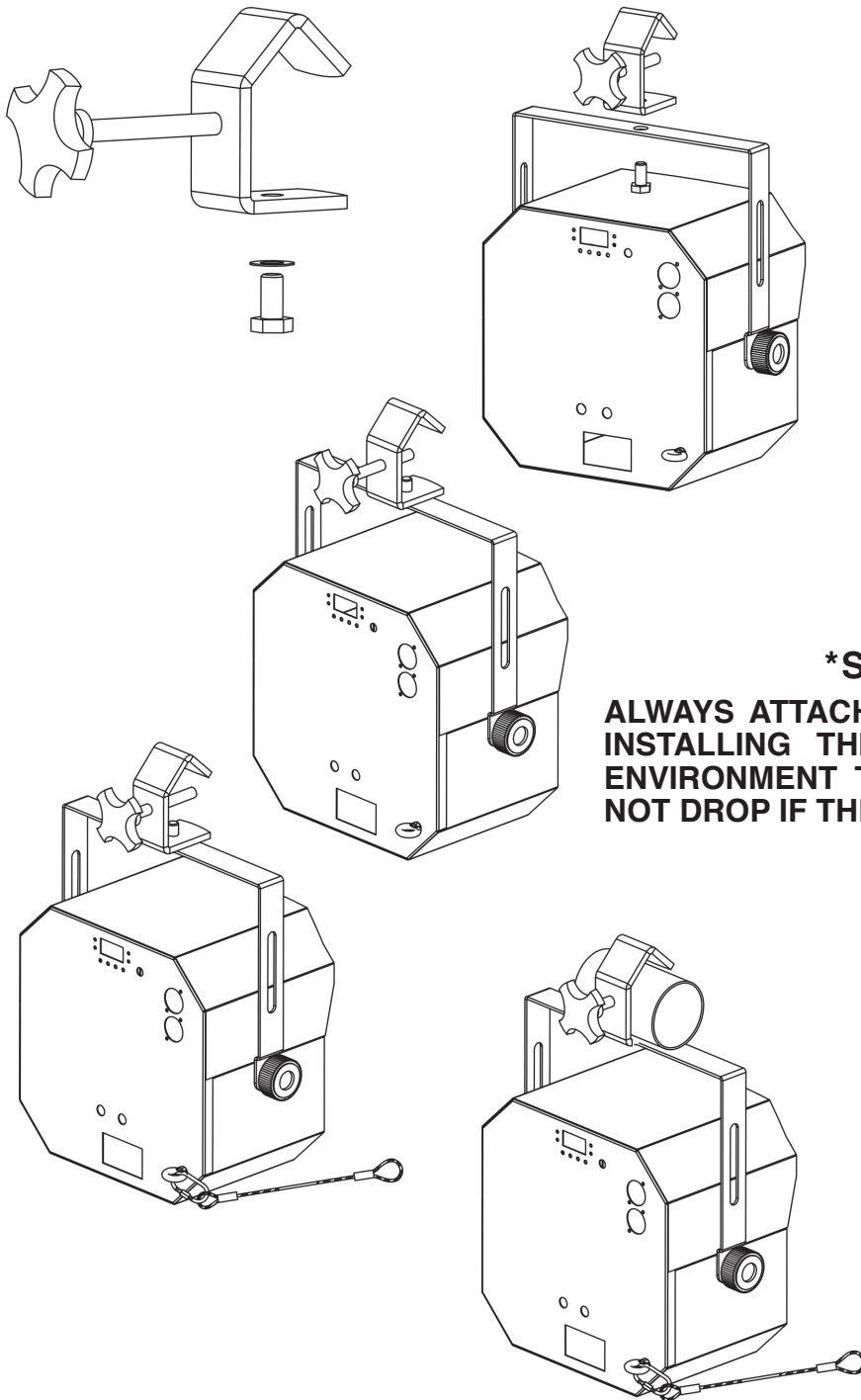

***SAFETY CABLE**

ALWAYS ATTACH A SAFETY CABLE WHENEVER INSTALLING THIS FIXTURE IN A SUSPENDED ENVIRONMENT TO ENSURE THE FIXTURE WILL NOT DROP IF THE CLAMP FAILS.

RIGGING

Overhead rigging requires extensive experience, including but not limited to: calculating working load limits, understanding the installation material being used, and periodic safety inspection of all installation material and the fixture itself. If you lack these qualifications, do not attempt to perform the installation yourself. Improper installation can result in bodily injury.

DMX SETUP

DMX-512: DMX is short for Digital Multiplex. This is a universal protocol used as a form of communication between intelligent fixtures and controllers. A DMX controller sends DMX data instructions from the controller to the fixture. DMX data is sent as serial data that travels from fixture to fixture via the DATA “IN” and DATA “OUT” XLR terminals located on all DMX fixtures (most controllers only have a DATA “OUT” terminal).

DMX Linking: DMX is a language allowing all makes and models of different manufacturers to be linked together and operate from a single controller, as long as all fixtures and the controller are DMX compliant. To ensure proper DMX data transmission, when using several DMX fixtures try to use the shortest cable path possible. The order in which fixtures are connected in a DMX line does not influence the DMX addressing. For example, a fixture assigned a DMX address of 1 may be placed anywhere in a DMX line: at the beginning, at the end, or anywhere in the middle. When a fixture is assigned a DMX address of 1, the DMX controller knows to send DATA assigned to address 1 to that unit, no matter where it is located in the DMX chain.

Data Cable (DMX Cable) Requirements (For DMX Operation): This device can be controlled via DMX-512 protocol. The DMX address is set using the display screen on the back of the device. Your unit and your DMX controller require a standard 3-pin XLR connector for data input and data output (Figure 1). We recommend Accu-Cable DMX cables. If you are making your own cables, be sure to use standard 110-120 Ohm shielded cable (This cable may be purchased at almost all pro lighting stores). Your cables should be made with a male XLR connector on one end and a female XLR connector on the other. Also remember that DMX cable must be daisy chained and cannot be split.



Notice: Be sure to follow figures two and three when making your own cables. Do not use the ground lug on the XLR connector. Do not connect the cable’s shield conductor to the ground lug or allow the shield conductor to come in contact with the XLR’s outer casing. Grounding the shield could cause a short circuit and erratic behavior.

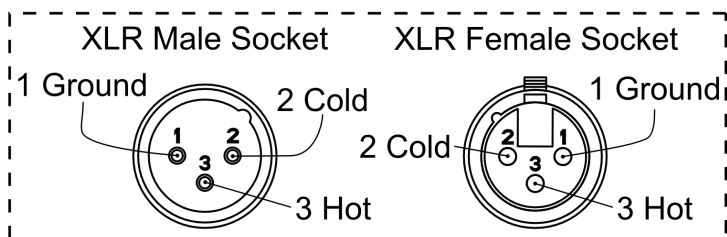
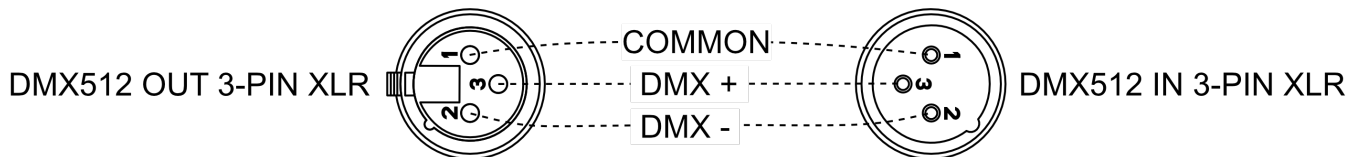

XLR Pin Configuration
Pin 1 = Ground
Pin 2 = Data Compliment (negative)
Pin 3 = Data True (positive)

DMX SETUP

Special Note: Line Termination. When longer runs of cable are used, you may need to use a terminator on the last unit to avoid erratic behavior. A terminator is a 110-120 ohm 1/4 watt resistor which is connected between pins 2 and 3 of a male XLR connector (DATA + and DATA -). This unit is inserted in the female XLR connector of the last unit in your daisy chain to terminate the line. Using a cable terminator (ADJ part number Z-DMX/T) will decrease the possibilities of erratic behavior.

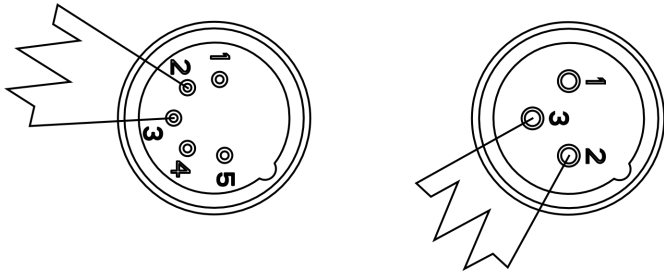

A DMX512 terminator reduces signal errors, avoiding most signal reflection interference. Connect PIN 2 (DMX-) and PIN 3 (DMX+) of the last fixture in series with a 120 Ohm, 1/4 W Resistor to terminate the DMX512.

5-Pin XLR DMX Connectors: Some manufactures use 5-pin DMX- 512 data cables for DATA transmission in place of 3-pin. 5-pin DMX fixtures may be integrated into a 3-pin DMX line with a 5-pin to 3-pin adapter cable. Although these adapters are available at most electric stores, one can be assembled using the conversion chart.

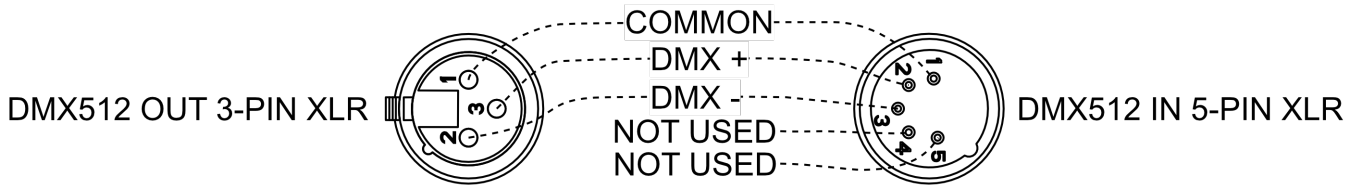

3-Pin XLR to 5-Pin XLR Conversion		
Ground/Shield	Pin 1	Pin 1
Data Compliment (- signal)	Pin 2	Pin 2
Data True (+ signal)	Pin 3	Pin 3
Not Used		Do Not Use
Not Used		Do Not Use

DMX ADDRESSING

All fixtures should be given a DMX starting address when operating with a DMX controller, in order to ensure that the correct fixture responds to the correct control signal. This digital starting address is the channel number from which the fixture starts to “listen” to the digital control signal sent out from the DMX controller. This starting DMX address is assigned by setting the correct DMX address on the digital control display on the fixture.

You can set the same starting address for all fixtures or a group of fixtures, or set different addresses for each individual fixture. Setting all fixtures to the same DMX address will cause all fixtures to react in the same way. In this case, please note that changing the settings of one channel will affect all the fixtures simultaneously.

If you set each fixture to a different DMX address, each unit will start to “listen” to the channel number you have set, based on the quantity of DMX channels of each fixture. That means changing the settings of one channel will only affect the selected fixture.

As an example, since this device has 9 DMX channels, you should set the starting DMX address of the first unit to 1, the second unit to 10 (1 + 9), the third unit to 19 (1+ 9 + 9), and so on.

Channel Mode	Unit 1 Address	Unit 2 Address	Unit 3 Address	Unit 4 Address
9 Channels	1	10	19	28

SYSTEM MENU

CONTROL PANEL

The device includes an easy to navigate system menu that can be accessed via a set of control buttons located on the back face of the device below the digital display.

FUNC: Press to cycle through main menu options (Auto, Sound, Secd, DMX).

ENTER: Press to confirm selection and open up the option sub-menu, if applicable.

UP/DOWN: Press to scroll through menu or sub-menu options.

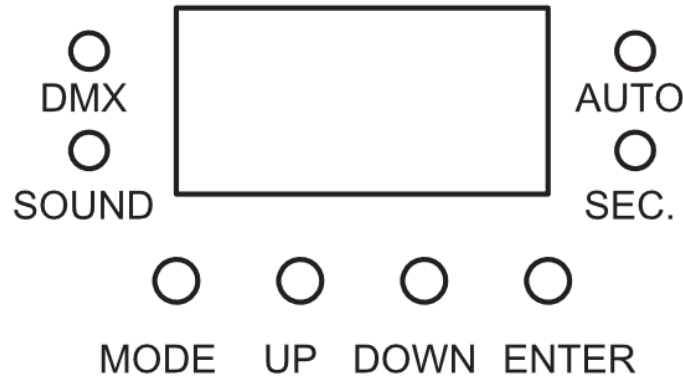

Menu	Submenu	Description
Auto	Aut0: Laser + RGBWY + 8x1WLED	ENTER to confirm, then UP/DOWN to select display speed. S0 (fastest) to S100 (slowest).
	Aut1: Laser + RGBWY	
	Aut2: Laser + 8x1WLED	
	Aut3: RGBWY + 8x1WLED	
	Aut4: RGBWY	
	Aut5: Laser	
	Aut6: 8x1WLED	
Sound	Sou0: Laser + RGBWY + 8x1WLED	ENTER to confirm, then adjust sensitivity with Sound Sensitivity Adjustment knob.
	Sou1: Laser + RGBWY	
	Sou2: Laser + 8x1WLED	
	Sou3: RGBWY + 8x1WLED	
	Sou4: RGBWY	
	Sou5: Laser	
	Sou6: 8x1WLED	
Secd	When selected, the unit will follow the movements of a designated primary unit.	NOTE: A flashing display screen indicates a poor connection to the primary unit. Please check the cable connections.
DMX	D001 - D506	NOTE: A flashing display screen indicates a poor DMX connection. Please check the cable connections.

DMX TRAITS: CHANNEL FUNCTIONS & VALUES (9 DMX Channels)

9CH	Values	Functions
1		Mode
	0 - 9	No Function
	10 - 24	Aut0
	25 - 39	Aut1
	40 - 54	Aut2
	55 - 69	Aut3
	70 - 84	Aut4
	85 - 99	Aut5
	100 - 114	Aut6
	115 - 129	Sou0
	130 - 144	Sou1
	145 - 159	Sou2
	160 - 174	Sou3
	175 - 189	Sou4
	190 - 204	Sou5
	205 - 220	Sou6
221 - 255	DMX Mode	
2		LED Operation
	0 - 9	No Function
	10 - 14	Red
	15 - 19	Green
	20 - 24	Blue
	25 - 29	Yellow
	30 - 34	White
	35 - 39	Red + White
	40 - 44	Red + Green
	45 - 49	Green + Blue
	50 - 54	Blue + Yellow
	55 - 59	Yellow + White
	60 - 64	Green + White
	65 - 69	Green + Yellow
	70 - 74	Red + Yellow
	75 - 79	Red + Blue
	80 - 84	Blue + White
	85 - 89	Red + Green + Blue
	90 - 94	Red + Green + Yellow
	95 - 99	Red + Green + White
	100 - 104	Red + Blue + Yellow
	105 - 109	Red + Blue + White
	110 - 114	Red + Yellow + White
	115 - 119	Green + Blue + Yellow
	120 - 124	Green + Blue + White
	125 - 129	Green + Yellow + White
	130 - 134	Blue + Yellow + White
	135 - 139	Red + Green + Blue + Yellow
	140 - 144	Red + Green + Blue + White
	145 - 149	Green + Blue + White + Yellow
150 - 154	Red + Green + White + Yellow	
155 - 159	Red + Blue + White + Yellow	
160 - 164	Red + Green + Blue + Yellow + White	
165 - 209	Automatic (single colors only)	
210 - 255	Automatic (two colors at a time)	

DMX TRAITS: CHANNEL FUNCTIONS & VALUES (9 DMX Channels)

9CH	Values	Functions
3	0 - 255	Automatic Speed , slow to fast (when CH2 is set to a DMX value between 165 - 209)
4		LED Strobe
	0 - 4	No Function
	5 - 254	Strobe Speed, slow to fast
	255	Sound-Activated Strobe Mode
5		8-piece LED Control
	0 - 9	No Function
	10 - 19	Picture 1, slow to fast
	20 - 29	Picture 2, slow to fast
	30 - 39	Picture 3, slow to fast
	40 - 49	Picture 4, slow to fast
	50 - 59	Picture 5, slow to fast
	60 - 69	Picture 6, slow to fast
	70 - 79	Picture 7, slow to fast
	80 - 89	Picture 8, slow to fast
	90 - 99	Picture 9, slow to fast
	100 - 109	Picture 10, slow to fast
	110 - 255	On
6		Laser
	0 - 9	No Function
	10 - 49	Red On
	50 - 89	Green On
	90 - 129	Red and Green Alternating Strobe (CH7 must be set to appropriate value)
	130 - 169	Red On, Green Strobe (CH7 must be set to appropriate value)
	170 - 209	Green On, Red Strobe (CH7 must be set to appropriate value)
210 - 255	Red and Green Strobe (CH7 must be set to appropriate value)	
7		Laser Strobe
	0 - 4	No Function
	5 - 254	Strobe, fast to slow
	255	Sound-Activated Strobe Mode
8		LED Rotate
	0 - 4	Stop
	5 - 127	Clockwise, slow to fast
	128 - 133	Stop
	134 - 255	Counter-clockwise, slow to fast
9		Laser Rotate
	0 - 4	Stop
	5 - 127	Rotate Clockwise, slow to fast
	128 - 133	Stop
	134 - 255	Rotate Counter-Clockwise, slow to fast

DIMMER MODE CHART

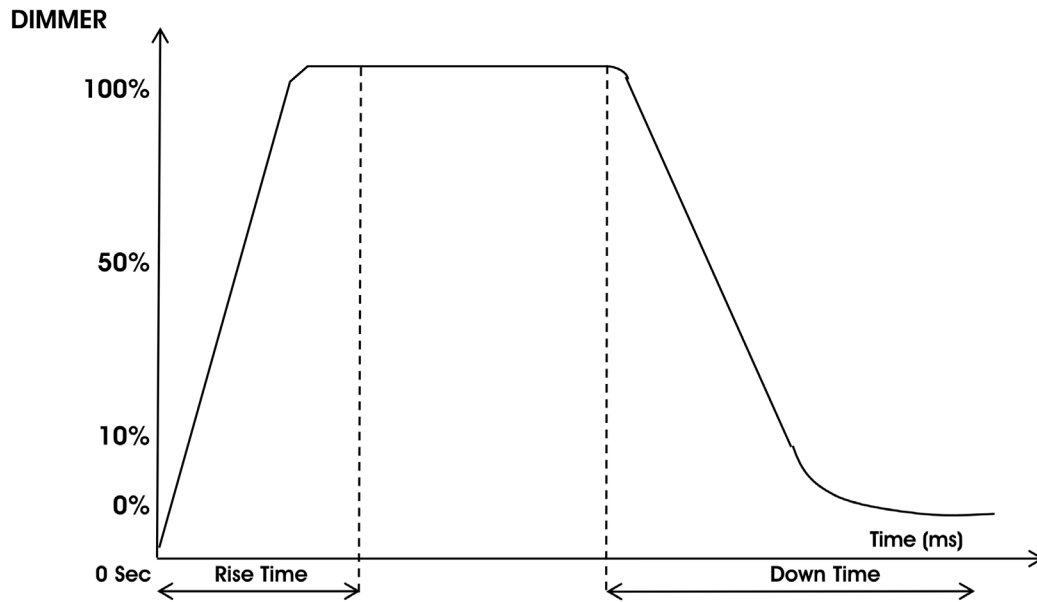

Dimming Curve Ramp Effect	0 sec Fade Time		1 sec Fade Time	
	Rise Time (ms)	Down Time (ms)	Rise Time (ms)	Down Time (ms)
Standard (default)	0	0	0	0
Stage	780	1100	1540	1660
TV	1180	1520	1860	1940
Architectural	1380	1730	2040	2120
Theatre	1580	1940	2230	2280
Stage 2	0	1100	0	1660

Dimming Speed	
DMX Value	Delay and Menu Display Time
121	0.1Sec.
122	0.2Sec.
123	0.3Sec.
124	0.4Sec.
125	0.5Sec.
126	0.6Sec.
127	0.7Sec.
128	0.8Sec.
129	0.9Sec.
130	1.0Sec.
131	1.5Sec.
132	2.0Sec.
133	3.0Sec.
134	4.0Sec.
135	5.0Sec.
136	6.0Sec.
137	7.0Sec.
138	8.0Sec.
139	9.0Sec.
140	10Sec.

CLEANING AND MAINTENANCE



DISCONNECT POWER BEFORE PERFORMING ANY CLEANING OR MAINTENANCE!

CLEANING

Frequent cleaning is recommended to ensure proper function, optimized light output, and an extended life. The frequency of cleaning depends on the environment in which the device operates: damp, smoky, or particularly dirty environments can cause greater accumulation of dirt on the fixture housing and/or light fixture optics. Clean the external surface and the front lens of the device periodically with a soft cloth to avoid dirt/debris accumulation

NEVER use alcohol, solvents, or ammonia-based cleaners.

MAINTENANCE

Regular inspections are recommended to ensure proper function and extended life. There are no user serviceable parts inside these devices; please refer all other service issues to Eliminator Lighting. Should you need any spare parts, please order genuine parts from Eliminator Lighting.

Please refer to the following points during routine inspections:

- A detailed review should be performed by an approved electrical engineer every three months, to make sure the circuit contacts are in good condition in order to prevent overheating.
- Be sure all screws and fasteners are securely tightened at all times. Loose screws may fall out during normal operation, resulting in damage or injury as larger parts could fall.
- Check for any deformations on the unit. Deformations could allow for dust to enter into the device, or cause the device to fall and seriously injure a person(s).
- Electric power supply cables must not show any damage, material fatigue, or sediments.

FUSE REPLACEMENT

This device features a replaceable fuse located alongside the Power Input on the back side of the device. To access the fuse, use a flat head screwdriver to catch the groove in the wall of the Power Input. **BE CAREFUL NOT TO DAMAGE THE FUSE CLIP, THE POWER INPUT, OR THE PRONGS.** When replacing the fuse, be sure to replace the correct one, as the fuse clip contains both an operational fuse and a spare fuse. **Replace the fuse only with an identical F2A 250V fuse.**

SPECIFICATIONS

- 3-FX-IN-1 dance party lighting effect: LED Moonflower, Wash and laser effects
- Dozens of razor-sharp beams fill a dance floor, ceiling or wall
- Moonflower: 5 x 3W (RGBWY) 5-in-1 LEDs
- Wash: 6 x 3W (RGBY) Quad LEDs
- Laser: Red & Green laser diodes
- 4 control mode: DMX, Sound Active, Auto, Primary/Secondary
- 4-button LED display menu
- 9 DMX channels
- Electronic dimming: 0-100%
- 3-pin DMX In/Out
- IEC AC In/Out connectors to daisy chain power
- Laser On/Off with safety key
- Safety eye on rear panel
- Built-in microphone with sensitivity potentiometer
- With wired digital communication network
- Power Draw: 40W max
- Dimensions: 11.8" x 12.25" x 8.9" / 300x312x226mm
- Weight: 8 lbs. / 3.7 kg.
- Laser accession number: 2110902-000

DIMENSIONS

